

EV CHARGING ANALYZER/SIMULATOR (AC/DC-CCS)

Generation 4



The EV Charging Analyzer is the technical standard in the analysis of the e-mobility charging process.

Analysis according to AC: IEC 61851-1, SAE J1772 and GB/T 18487.1-2015 Annex A (AC) and DC: IEC 61851-1, DIN 70121, ISO 15118, SAE J1772 and IEC 61851-23 Annex CC.

EV Charging Analyzer
for AC and DC-CCS extendable
(mobile version).

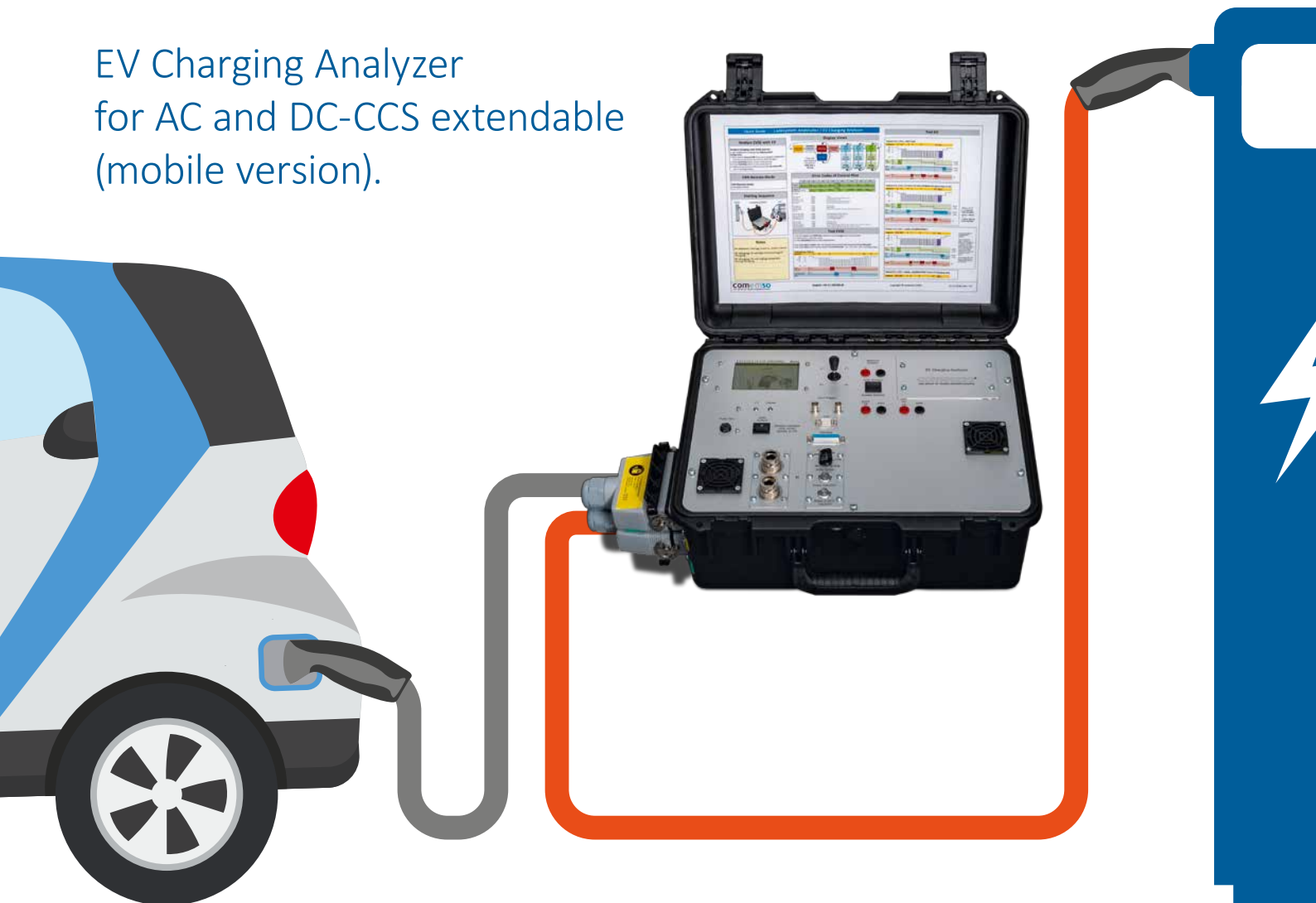

comemso meets new challenges with high quality.

Developments in e-mobility present new challenges for vehicle and charging-system manufacturers. Due to high availability of the 230V AC main power supply, conductive charging systems for electric vehicles are now widespread. The relatively new standards IEC 61851-1, DIN 70121, ISO 15118 and SAE J1772 describe the requirements for European and US AC- and DC-charging-systems, electrical waveforms and the pilot signal to control the charging process. By combining electric vehicles and charging systems from various manufacturers,

different system-tolerances and disturbing influences may occur. The causes of charge interruptions are very difficult to locate due to the long charging period.

The comemso EV Charging Analyzer / Simulator measures and verifies both the communication and the load circuit on standard-conformity over the complete duration of charging and records all deviations. Thus causes of charge interruptions can be identified and causalities of events can be detected and visualised.

EV Charging Analyzer for DC-CCS (rack version).

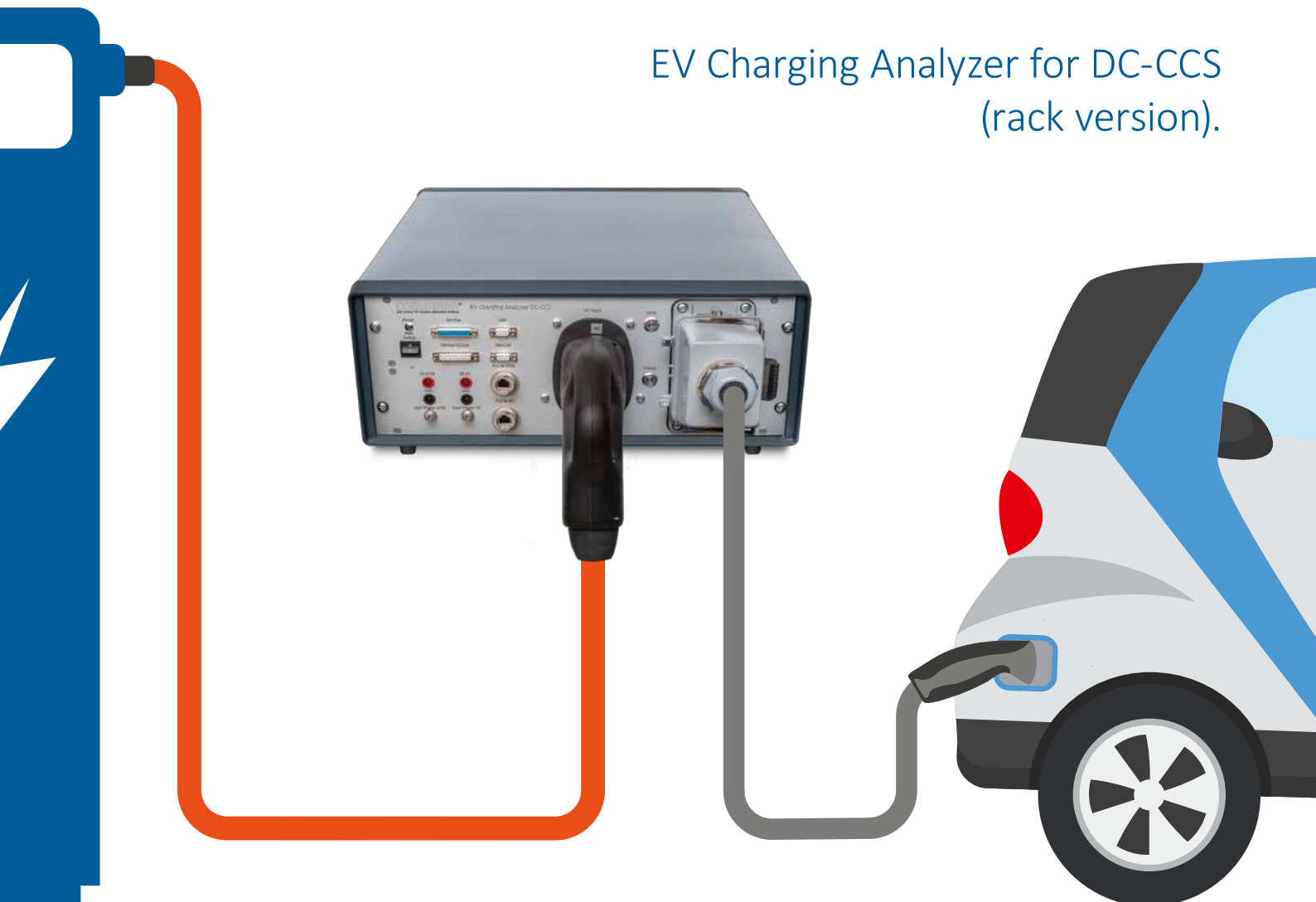

Global features.



Leading measurement technology in the field of the charging system analysis.

AC analysis according to IEC 61851-1 charging mode 1, 2 and 3, SAE J1772 and GB/T 18487.1-2015 (AC only).

DC analysis according to IEC 61851-1 charging mode 4, DIN 70121, ISO 15118 and SAE J1772, as well as IEC 61851-23 Annex CC (option).

Acts as PLC tracer (trace SLAC, V2G messages) with real measured AC/DC current and voltage on same time stamp.

No oscilloscope required! Hard real-time and automated testing for compliance with standards of the control pilot signal in each period over several hours.

Causes of charge interruptions or damages of components can be detected and logged, e.g. on “intolerance” between a specific electric vehicle with a specific charging station.

Long-term analysis of the entire charging process.

Real-time measurement, analysis and control over CAN interface functional tests (EV test / EVSE test) available, half-automated and with test libraries.

Large number of connectors and adapters for different charging connector interfaces and applications.

Modular expansion options, for software and hardware.

Robust casing for mobile outdoor use, battery-powered, IP66 in closed case, IP54 in open case.

Intuitive operation / easy test automation.

In use successfully at premium EV / EVSE manufacturers.



CP Communication self-test.

In field tests, it is sometimes difficult to identify the cause of unusual behaviour. It's easy to check the measurement and simulation system on its own to ensure its proper working and calibration state. Therefore the EV Charging Analyzer (EVCA) can be self-tested by being connected to itself. Then EV simulation, EVSE simulation and measurement of the EVCA run alongside each other.

Verification of charging and grid quality.

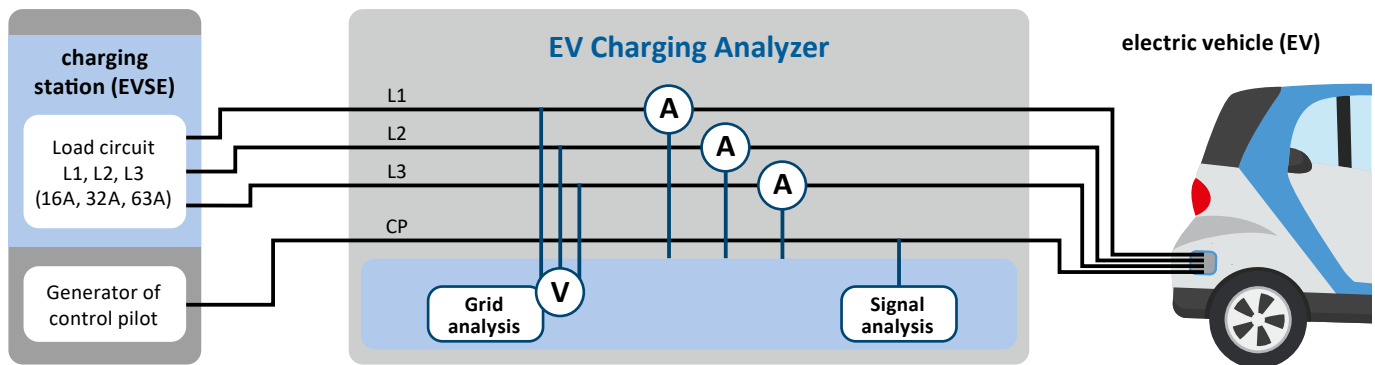

Special options and extensions.

For an overview of further options to extend the basic functions and/or communication of the comemso EV Charging Analyzer, please contact: sales@comemso.de

Useable in challenging environments.

Successfully tested at Joint Research Centre of the European Commission in Ispra/Italy, even under extreme conditions (e.g. in climatic chamber at -25°C) and in other countries around the world (e.g. from Europe, USA, Asia, cold and hot climate testing).

Technical features

Capture of AC/DC voltage + current of the load circuit, for AC also frequency, harmonic interferences up to 5 kHz with SnapShot function (see page 8).

Calculation of AC power (W) and energy (Wh) for L1, L2, L3 based on TrueRMS measurement of voltage and current.

Identification of permitted current, which is communicated via CP / PLC and synchronously comparable with real current flow in the load circuit.

Analysis of control pilot signal and all its parameters. High accuracy measurement methods, developed especially for analysis of electrical signals described in IEC 61851-1.

Features of AC/DC version

Identical to field version of EV Charging Analyzer → interchangeable test routines and control settings.

Switchable between AC and DC charging.

Customer-specific HV source and load (AC/DC) can be integrated with remote control.

Optional extendable with further test automation tools (e.g. comemso EV Plug Cycle Emulation).

Fully integrated in Vector CANoe/vTESTstudio for test automation.

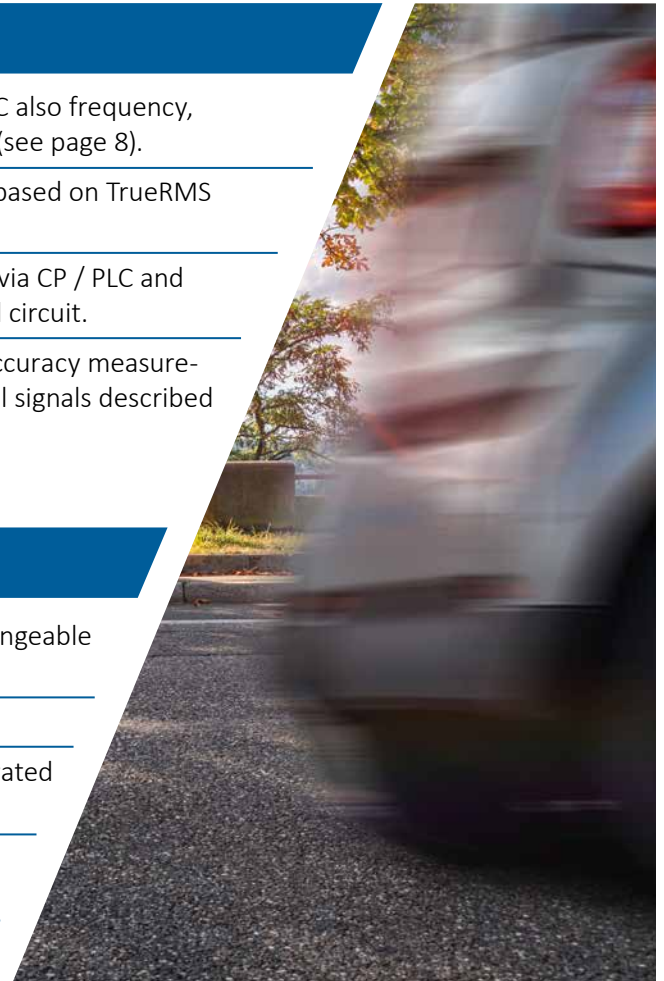

No oscilloscope can do this!

Time synchronous measurement of AC/DC power circuit and communication signals without losses over hours and hours, with logging option. As Man-in-the-Middle, or as EV test/EVSE test. Available comemso test libraries and conformance analysis complete the EV Charging Analyzer/Simulator.

Ideal matching of hardware and software – our basic system architecture:

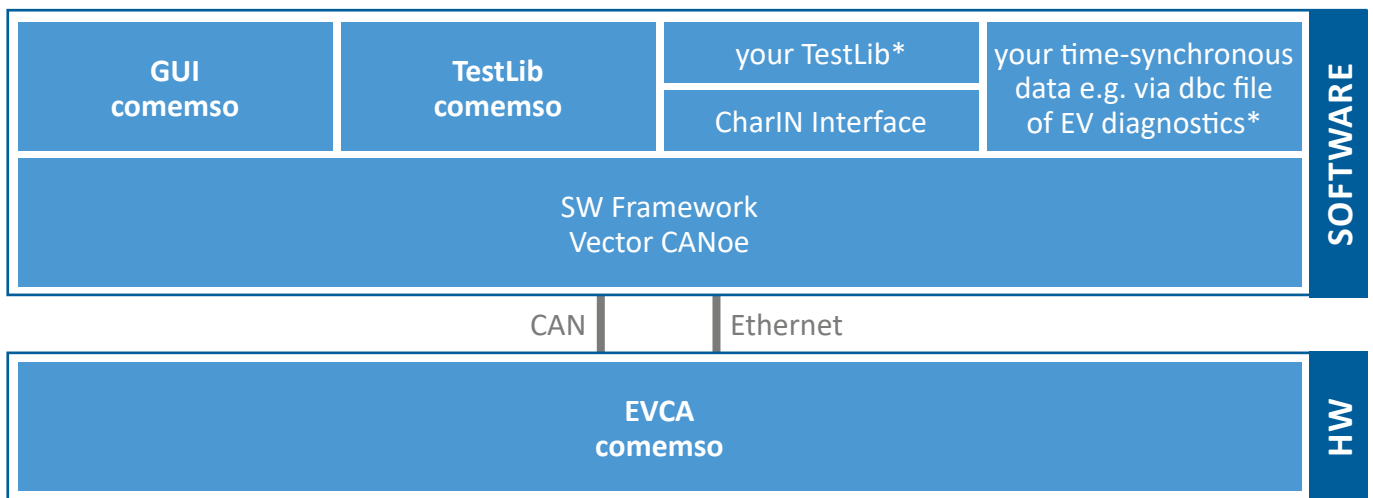

System architecture with globally established components in the automotive sector.
Ready to use system with short introduction effort.
*Requires CANoe PRO version.

Real-time user interface with various test and measurement options.

Convenient user interface designed by comemso for the EV Charging Analyzer with Vector CANoe software. Visualisation and control via CAN.

Benefits:

- ▶ Remote control of the EVCA using your PC.
- ▶ Synchronous measurement with other CAN data, e.g. from your EV/charger.
- ▶ Convenient logging and replay function.
- ▶ Convenient analysis function by traces and graphics window of CANoe (synchronised).
- ▶ Ready test automation or even complete Test libraries (options).

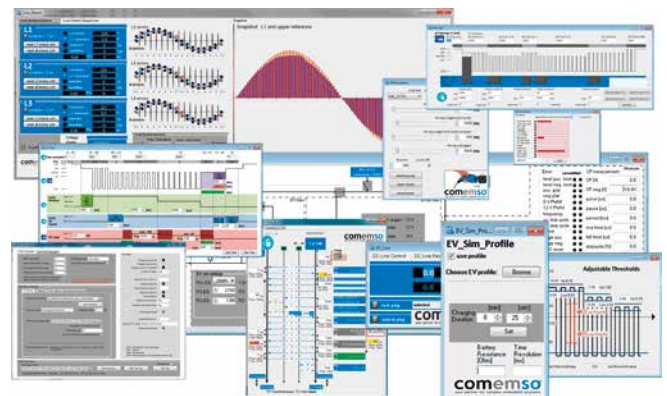

Helps to easier understand the complex charging process due to graphical visualisation for analysis and configuration!

Real-time visualisation on device display.

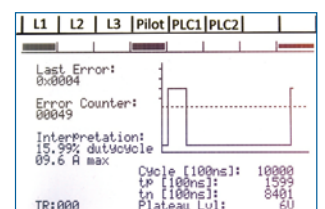
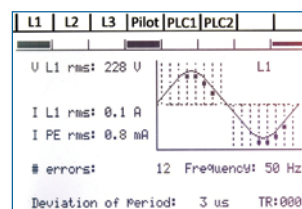

Engineered for different kind of use.

Charging verification (Man-in-the-Middle/series circuit analysis):



For more information, see page 8.



For more information, see page 9.

Simulation of EV and/or EVSE:

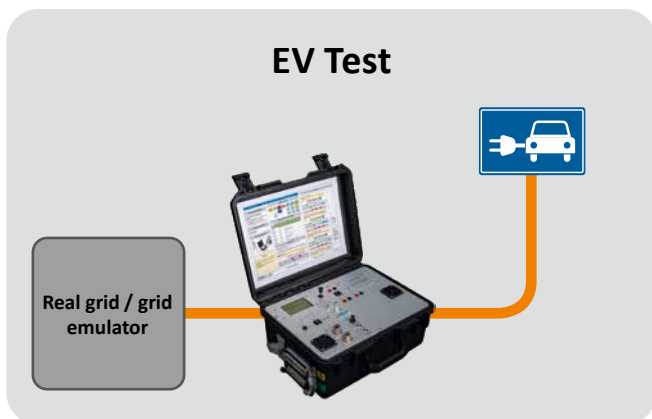

For more information, see page 10.



For more information, see page 11.

Outdoor/field or lab system possible:

Field application



Lab application





Measurement data analysis online/offline.

Real-time-measurement of all signal parameters via Control Pilot. In each cycle, which is each millisecond!

Measurement results of control pilot.

Error	currentTest	CP measurement	Measure
level pos. limit	●	CP [V]	8.78
level neg. limit	●	CP neg [V]	-12.2V
pos. plat	●	pulse [us]	59.7
neg. plat	●	pause [us]	940.9
0 V PWM	●	period [ms]	1000.6
12 V PWM	●	rise time [us]	0.0
frequency	●	fall time [us]	0.0
sz. duty cycle	●	duty cycle [%]	6.0
ch. duty cycle	●	max. current [A]	
noise	●		
edge pos	●		
edge neg	●		
ADC reset	●		
level error	●		

Presentation of long-term measurement results of each cycle over time.

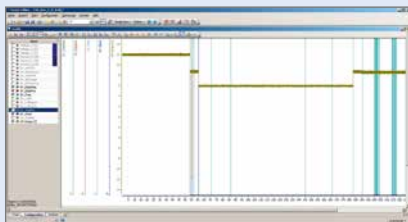
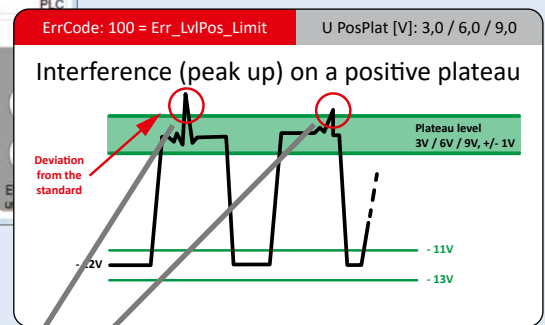
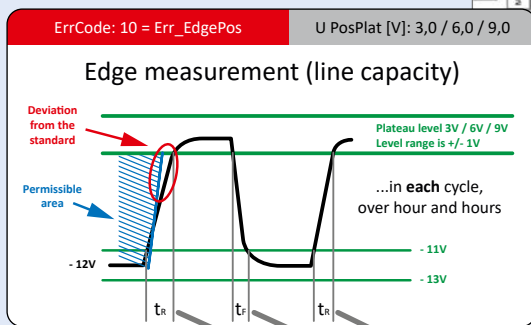

Show parameters of CP over time.



View Errors / Odds as logic analyzer.

Mains (AC voltage and current as TrueRMS)

Grid quality (L1, L2, L3)

Grid quality information of each sine wave.

Presentation of measurement results over time in Vector CANalyzer / CANoe.

Get detailed grid measurement, e.g. with automatic snapshot on grid disturbances.

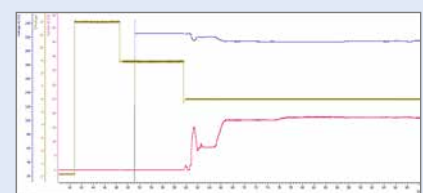
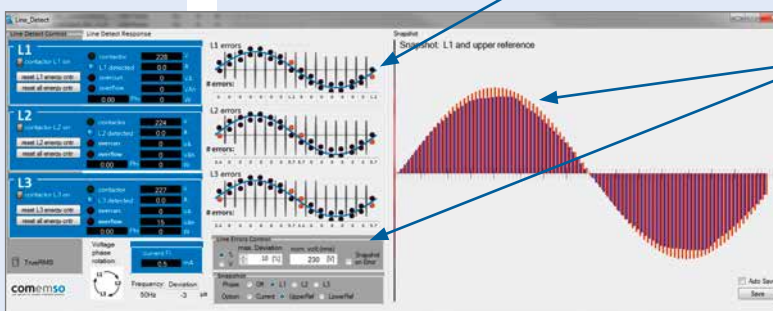

Time synchronous to communication data.



Measurement of DC PLC data with function “PLC-gateway”.

To give you an overview of the measurement between EV and EVSE with DIN 70121/ISO 15118, we display some more detailed images.

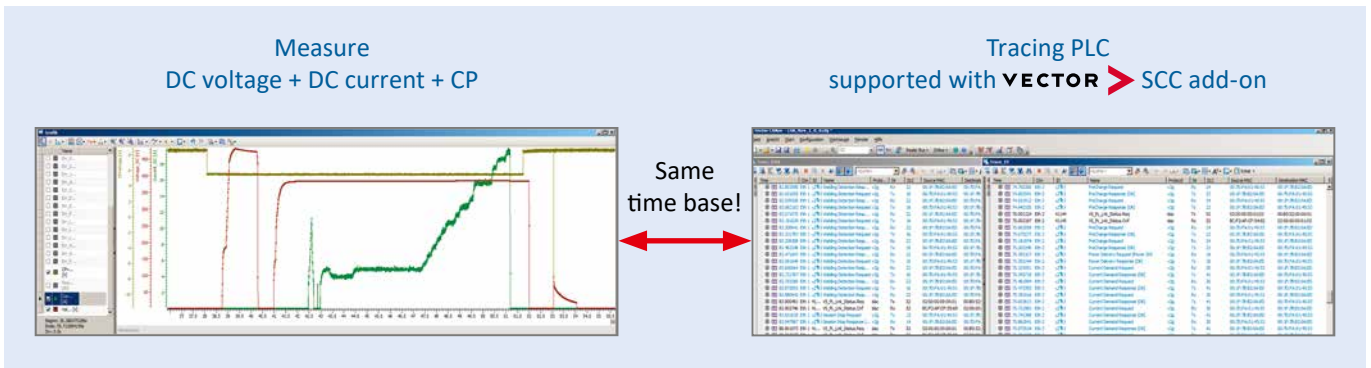

You can do the following:

- ▶ Monitor encrypted communication. (blue messages in picture: “PLC-Gateway_running”)
- ▶ Live comparison of the real measured values for DC voltage and DC current. (Picture: “PLC-Measurement”)
- ▶ Graphical comparison of the data communicated with the real measured values.

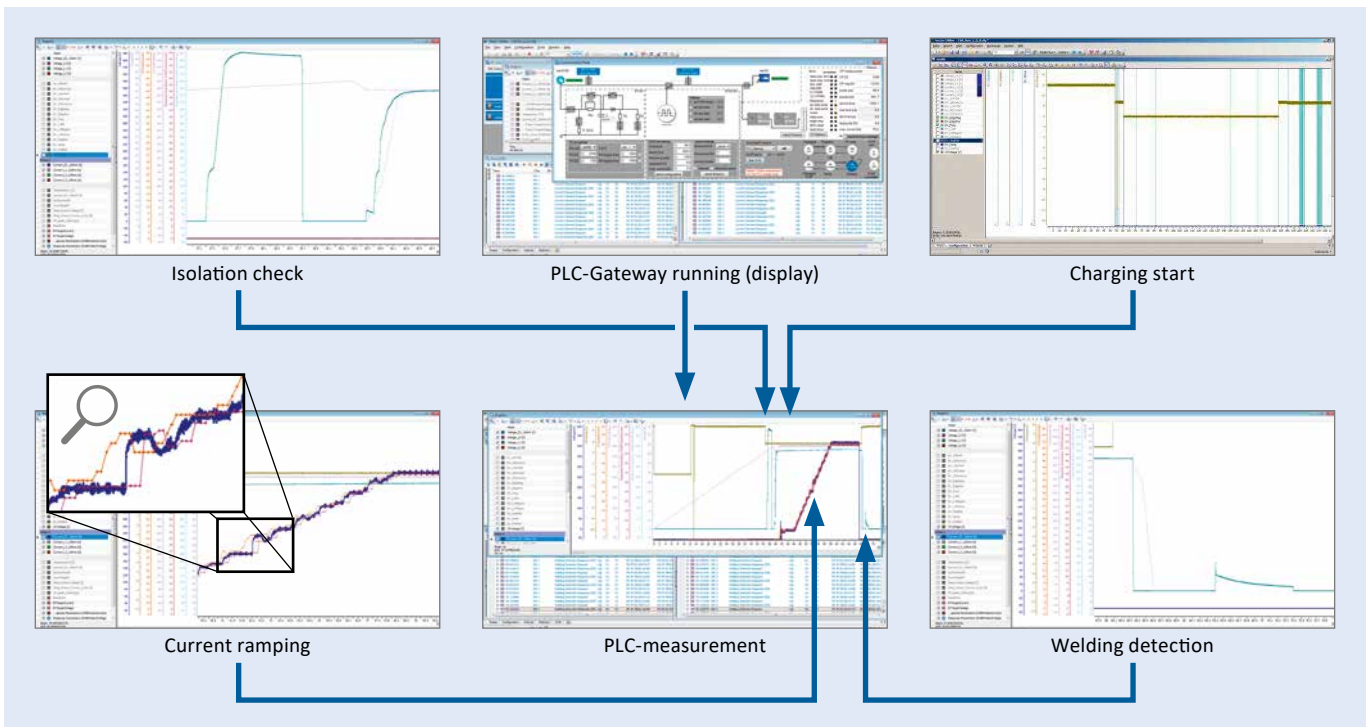

Caption:

Dark blue = Current measured by EV Charging Analyzer
 Dark red = Current measured by EVSE (from PLC data)
 Orange = Current requested by EV (from PLC data)

Blue-green = real measured Voltage by EV Charging Analyzer
 Light Blue = Voltage measured by EVSE (from PLC data)
 Violet = Battery voltage of EV (from PLC data)

EVCA measurement with PLC data sniffing.

With the additional sniffer function (HW + SW), which is optionally available for all EVCA systems (suitcase, rack, ...), you can read out the following, unadulterated data:

- ▶ original AC or DC voltage measurement of comemso hardware
- ▶ original PP resistor measurement
- ▶ original CP signal
- ▶ original SLAC messages between real EV and real EVSE
- ▶ original PLC messages

The decoding of TLS encrypted data is not possible. For this, the equally optional TLS-Gateway is required as listed below.



PLC-Sniffer module with EVCA suitcase

TLS decryption, extended Man-in-the-Middle.

If you want to use the comemso EVCA system as a Man-in-the-Middle, the system can not only measure without influence (no decryption), it also performs Man-in-the-Middle for DIN 70121 and ISO 15118 EXI decoding. Now also new: Man-in-the-

Middle for ISO 15118 PnC/TLS communication. This provides you the entire communication for analysis, including deeply encrypted messages, time-synchronous to the signals and power measurement (voltage/current).

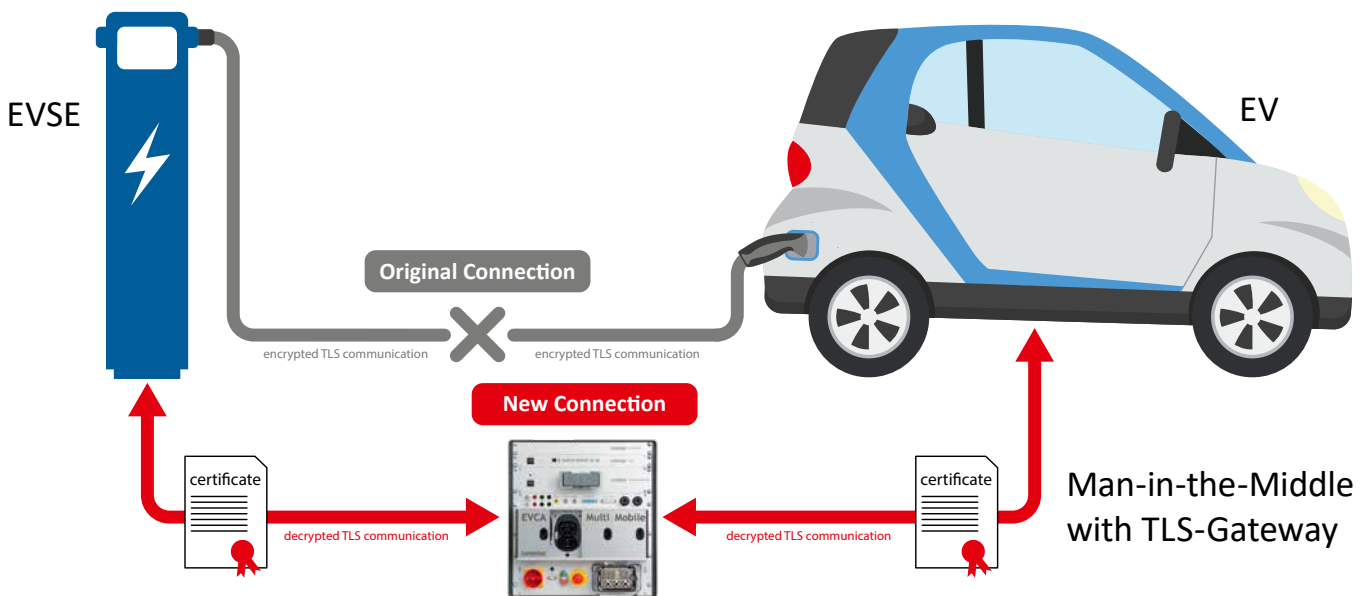



AC/DC-CCS – EV-Test.

Option 1: EVSE Simulation (EV test for limits, robustness).

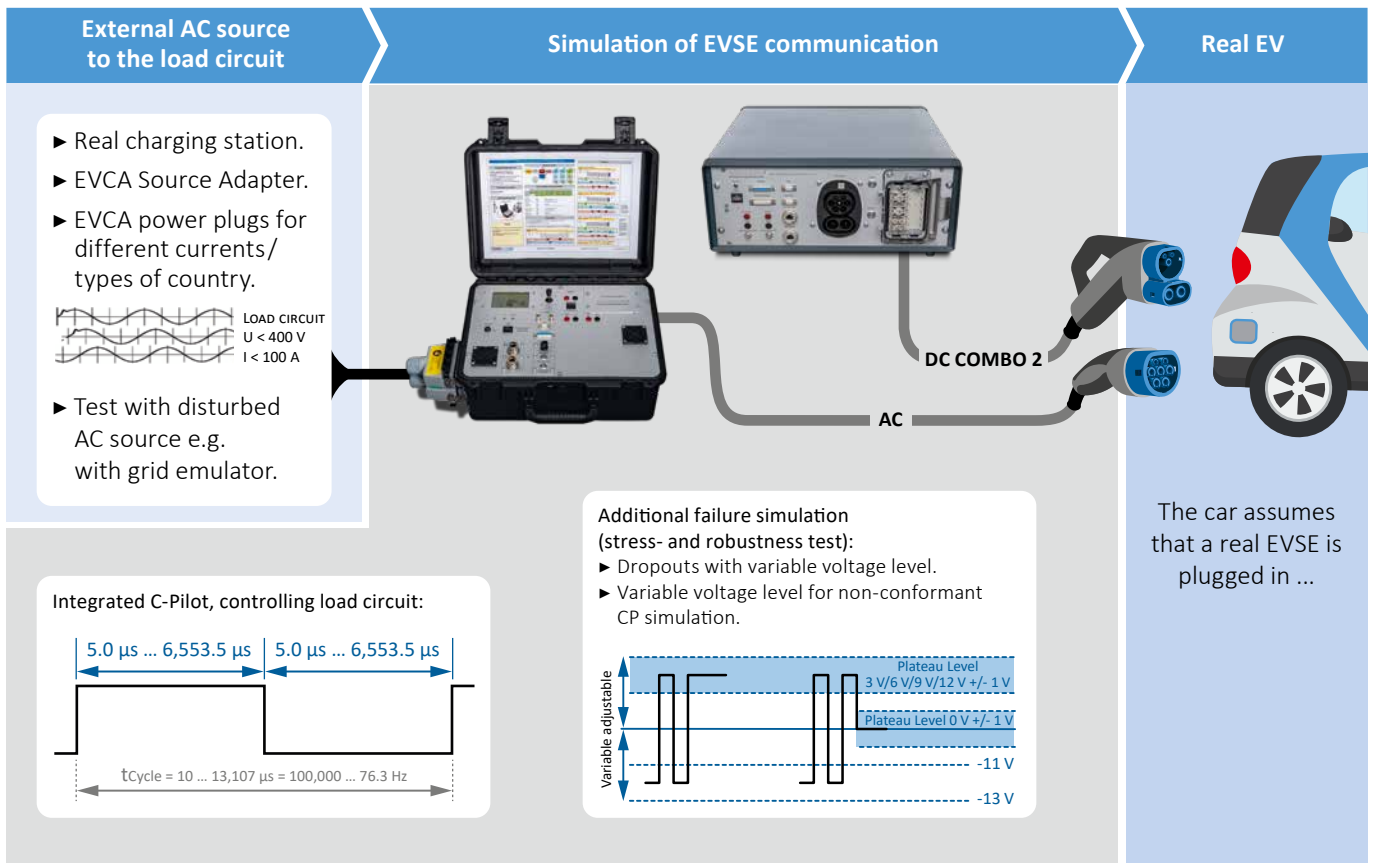

Full-automatic EV/EVCC test libraries.

Available test libraries to check standard conformity for EVs/EVCCs according to:

- IEC 61851-1 (AC)
- ISO 15118-4
- ISO 15118-5
- DIN 70122
- CharIN test cases (coming soon)



Further electrical functions: PP emulation.

With the emulation of the PP resistor, new possibilities arise due to the switch ON/OFF option, to emulate plugging and unplugging of connector. Simple solution with major benefits.

Check reliability of EV charging process. This test is usually executed for each new EV OBC firmware release.

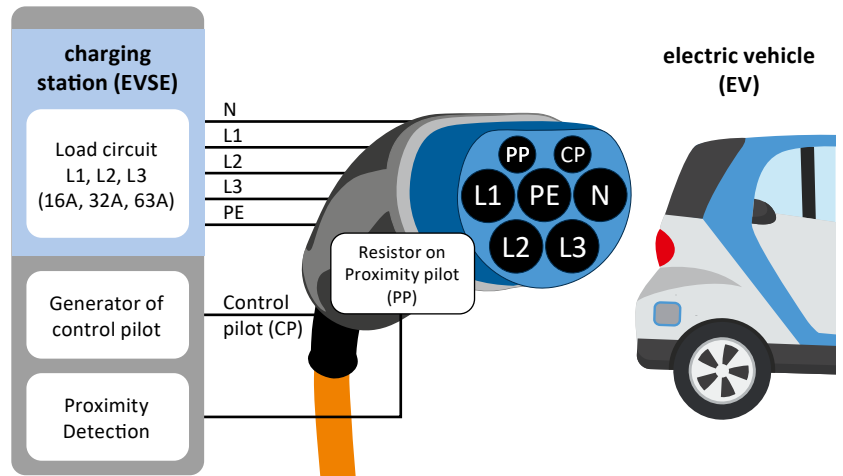

PP emulation/Plug cycle emulation.

Used also for test automation. Usable for EV test and EVSE test.

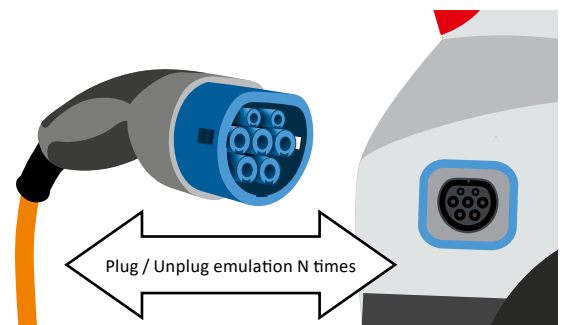
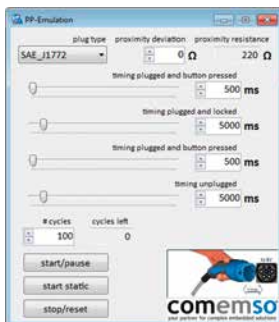

Plug cycle emulator.

- ▶ Emulation of cyclic plug tests, with tracing of Control pilot data and load circuit through EV Charging Analyzer.
- ▶ Change of PP resistor values (resolution 1 Ohm).
- ▶ For EV or EVSE side.
- ▶ On EV side: can be combined with automated EV test process for each cycle!

AC Test automation – Included with EVSE simulation option combined with plug cycle emulation.

Convenient CANoe panel from comemso:

- ▶ fully set up charge cycle
- ▶ configurable timings
- ▶ transparent control
- ▶ clear and traceable

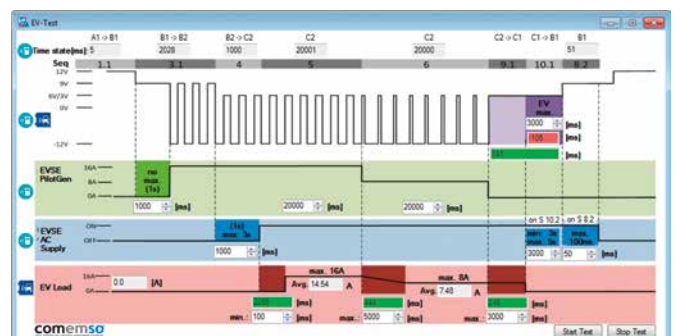



AC/DC-CCS – EVSE-Test.

EV simulation – Included in the basic version.

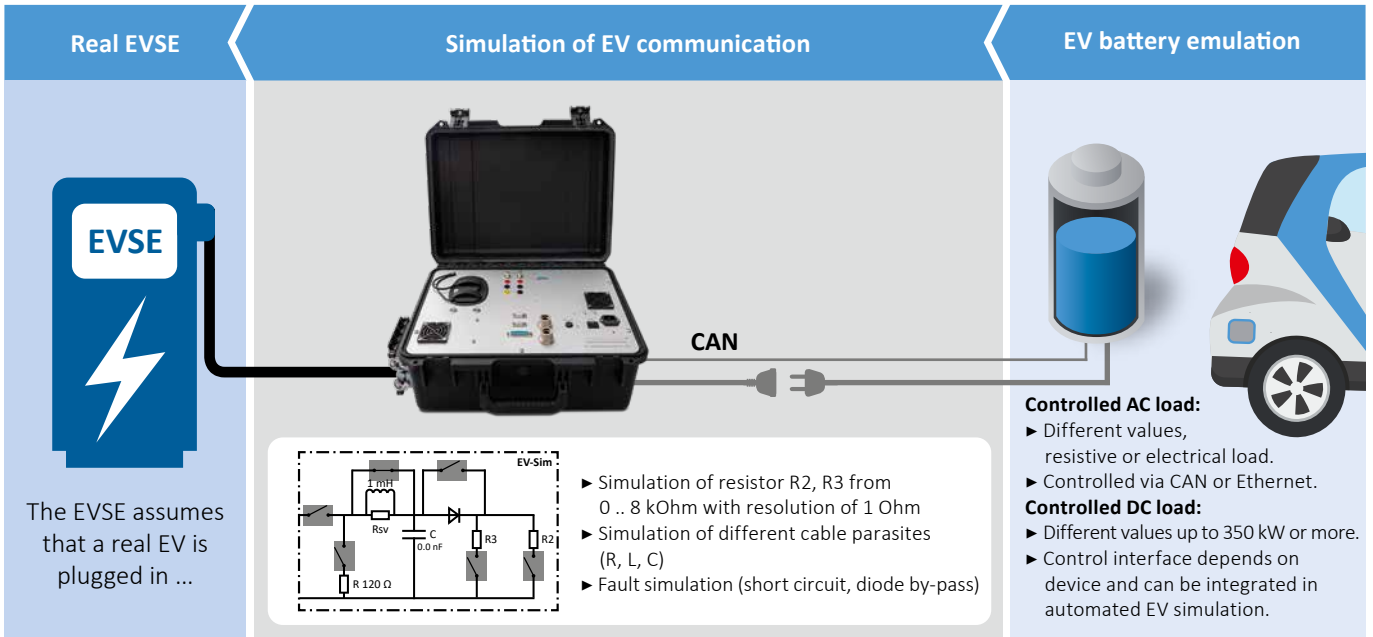

Full-automatic EVSE/SECC test libraries.

Available test libraries to check standard conformity for EVSEs/SECCs according:

- IEC 61851-1 (AC)
- IEC 61851-23 ed. 2, Annex CC (DC) – only EVSE
- ISO 15118-4
- ISO 15118-5
- DIN 70122
- CharIN test cases (coming soon)

Fast and automated verification of electrical standard conformity of EVSEs/SECCs. The library can be used in field operations to easily find EVSE errors, or during the EVSE development process for verification or regression testing.

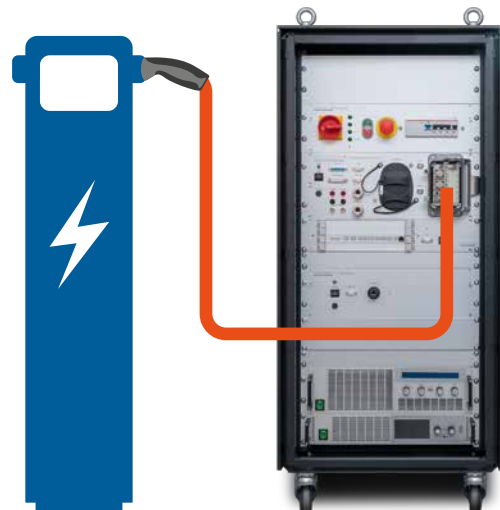
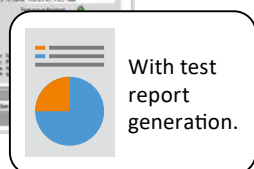
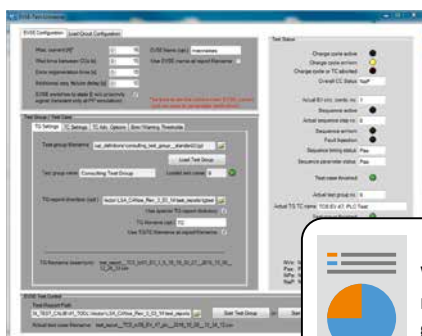

350kW applications.

DC application – EV Test (DC EVSE-Simulation):

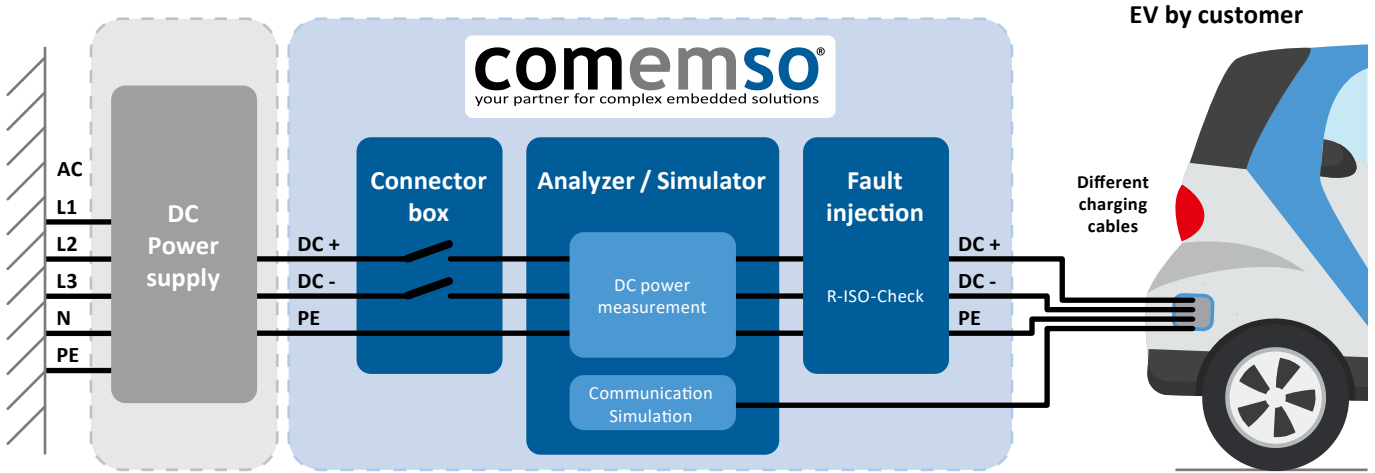

DC application – EVSE Test (DC EV-Simulation):

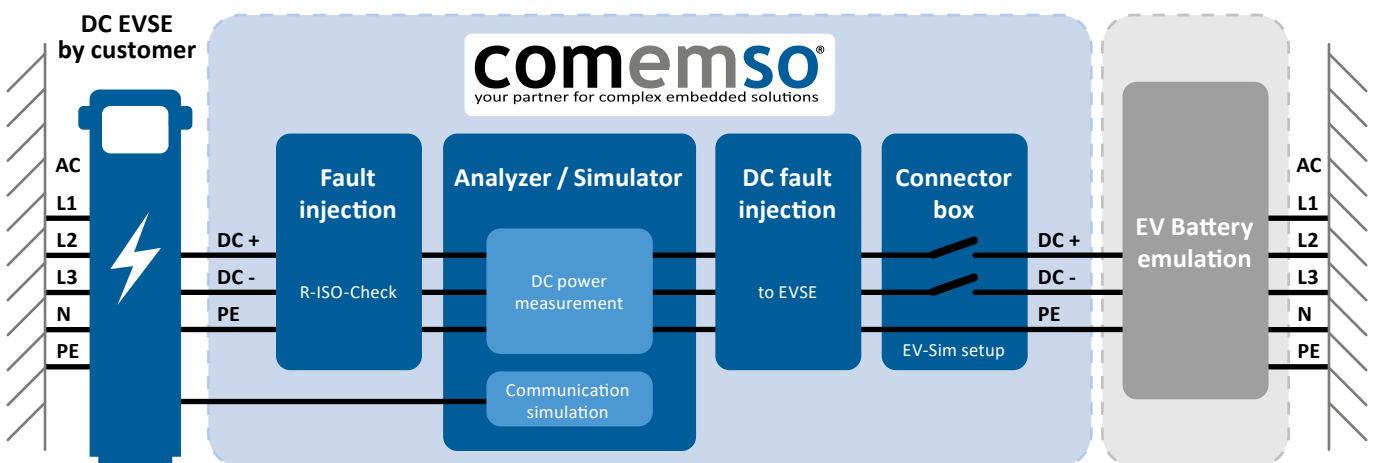

Example system for EV-Test, 350kW DC-CCS:



Example for a 400 kW battery emulator (not complete).

Example system for EVSE-Test, 350kW DC-CCS:



Software example:
Emulate different EV
current profiles.

Example for a 400 kW battery emulator (not complete).

Example system for EMC laboratory
IEC 61851-21-2 (EVSE-Test), IEC 61851-21-1 /
R010r5 (EV-Test) also available.

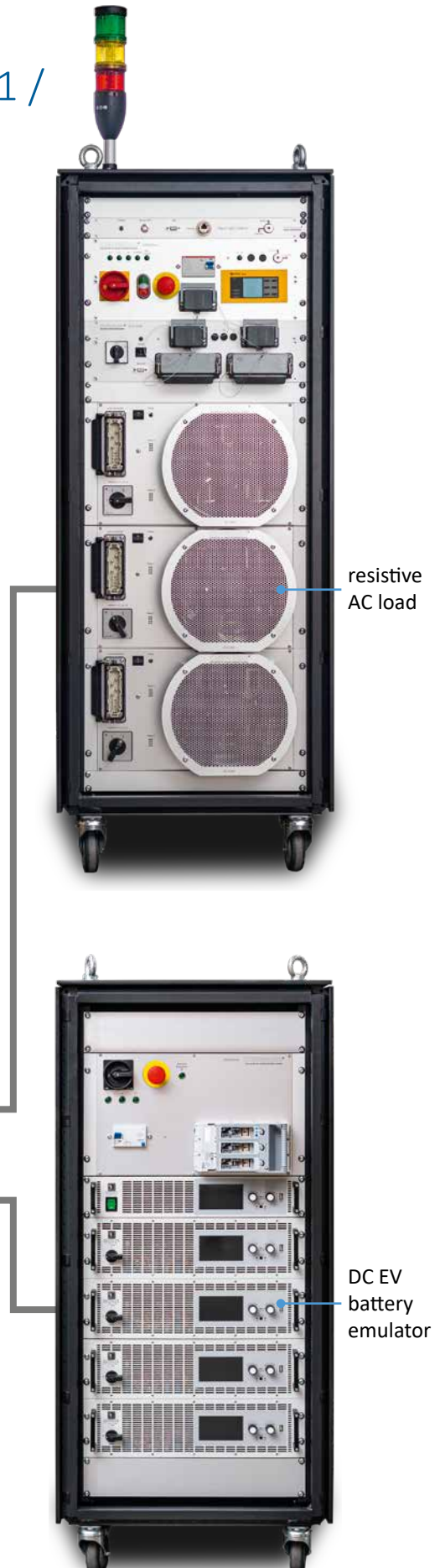

Technical data.

General

AC power supply voltage:	110 – 230VAC, int. 24 VDC battery
Weight:	15 kg
Size (L x W x D):	520mm x 390mm x 230mm
Operating temperature:	-20 .. +60 °C (without display/battery)
CAN interface:	CAN gateway for remote mode, 1MBit/s
Test/analysis standards:	E DIN EN 61851-1, SAE J1772, GB/T 18487.1-2015 (AC only)
Supported EV charging:	Conductive
EV charging power:	AC 120V/230V/240V split phase. Up to 3 phases, separately switchable.
EV charging current:	Up to 50A at the case, standard AC charging cable 32A, currently on request up to 40A available (Type 1).
EV charging frequency.	50/60Hz

Simulation range, accuracy etc.

EVSE-Sim on control pilot signal

Frequency of CP:	100kHz – 8Hz
Pulse and pause value:	5 – 60000µs
Resolution on timing:	500ns (Pulse and pause of PWM)
Accuracy on timing:	1µs (Pulse and pause of PWM)
Pilot voltage	
▶ Range:	+/- 13.8V
▶ Accuracy:	+/- 100mV
▶ Resolution:	7.463mV
▶ Protocol resolution (CAN):	7.463mV
Rise time (without capacity):	1.2 – 1.6µs (HW tolerance)
Fall time (without capacity):	1.2 – 1.6µs (HW tolerance)
Rise time (with 3.5nF capacity):	7.0 – 9.5µs
Fall time (with 3.5nF capacity):	8.0 – 10.0µs

Measurement data via CAN interface

Recording of state and error messages:	at 50Hz mains: max. 250 messages at 60Hz mains: max. 300 messages (messages for L1 .. L3 per sine cycle)
--	--

Simulation range, accuracy etc.

Control pilot signal

Cycle of measurement and CAN send:	each cycle of PWM signals (700µs .. 2ms)
Resolution of timing:	100ns (Pulse and pause of PWM signal)
Pilot voltage	
▶ Range:	+/- 13.8V
▶ Accuracy:	+/- 100mV
▶ Resolution:	7.463mV
▶ Protocol resolution (CAN):	7.463mV
Rise/fall time resolution (CAN):	100ns
Rise/fall time accuracy:	1µs

Load circuit

Line voltage	AC	DC
▶ Range:	0 .. 400V	5 .. 1000V
▶ Accuracy:	+/- 1 V True RMS, per line 100 measurement points	+/- 100mV +/- 0.5%, each 100µs measured, average of 100 measurement points → each 10ms a CAN message.
▶ Deviation to sine period:	+/- 128µs Range, 1µs resolution	
▶ Hardware resolution:	14.65 mV	15.25mV
Protocol resolution CAN:	1V	
Line current	AC	DC
▶ Range:	0 .. 50A (rms)	0.3 .. 200A
▶ Accuracy:	+/- 100mA true RMS, per line 100 measurement points	+/- 100mA +/- 1%, each 100µs measured, average of 100 measurement points → each 10ms a CAN message.
▶ Hardware resolution:	1.795mA	3.05 mA
Protocol resolution CAN:	100mA	
Leak current (FI) measurement	AC	DC
▶ Range:	+/- 300mA	depends on DC power
▶ Accuracy:	+/- 1mA DC	
▶ Hardware resolution:	9.466µA	
Protocol resolution CAN:	100µA	
Not available on devices with > 50A capability.		

EV = Electric Vehicle, EVSE = Electric Vehicle Supply Equipment, EVCA = EV Charging Analyzer

Product categorization matrix.

The product categorization matrix from comemso gives you an overview of the features and possibilities of the system presented in this brochure. This

helps you to find the right comemso system for your application.

General

Mobile suitcase version

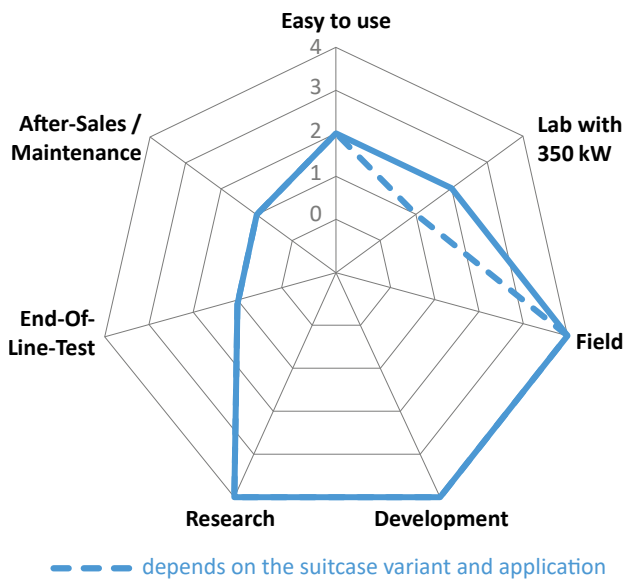

Laboratory rack version

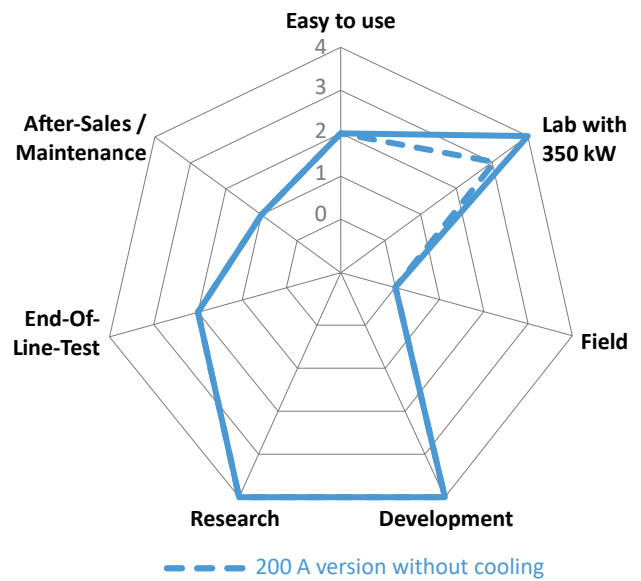

Mobile rack version

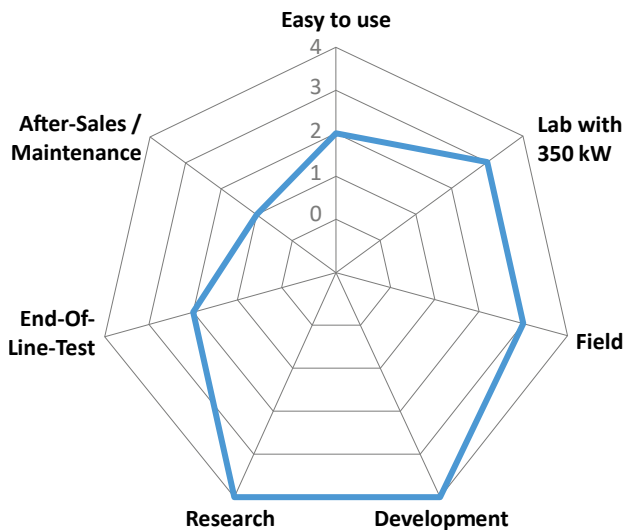

Applications

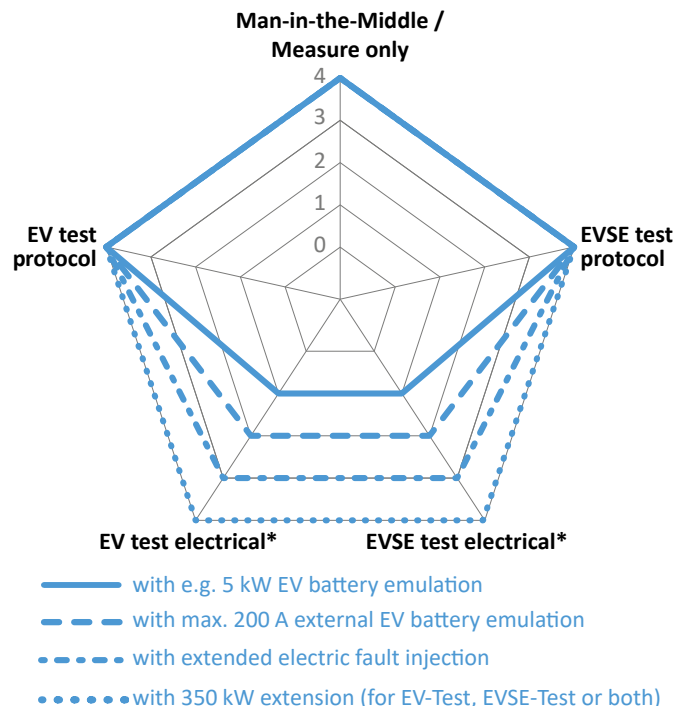

*The 350 kW device may cause limitations in other applications.

How to order a system with your requirements.

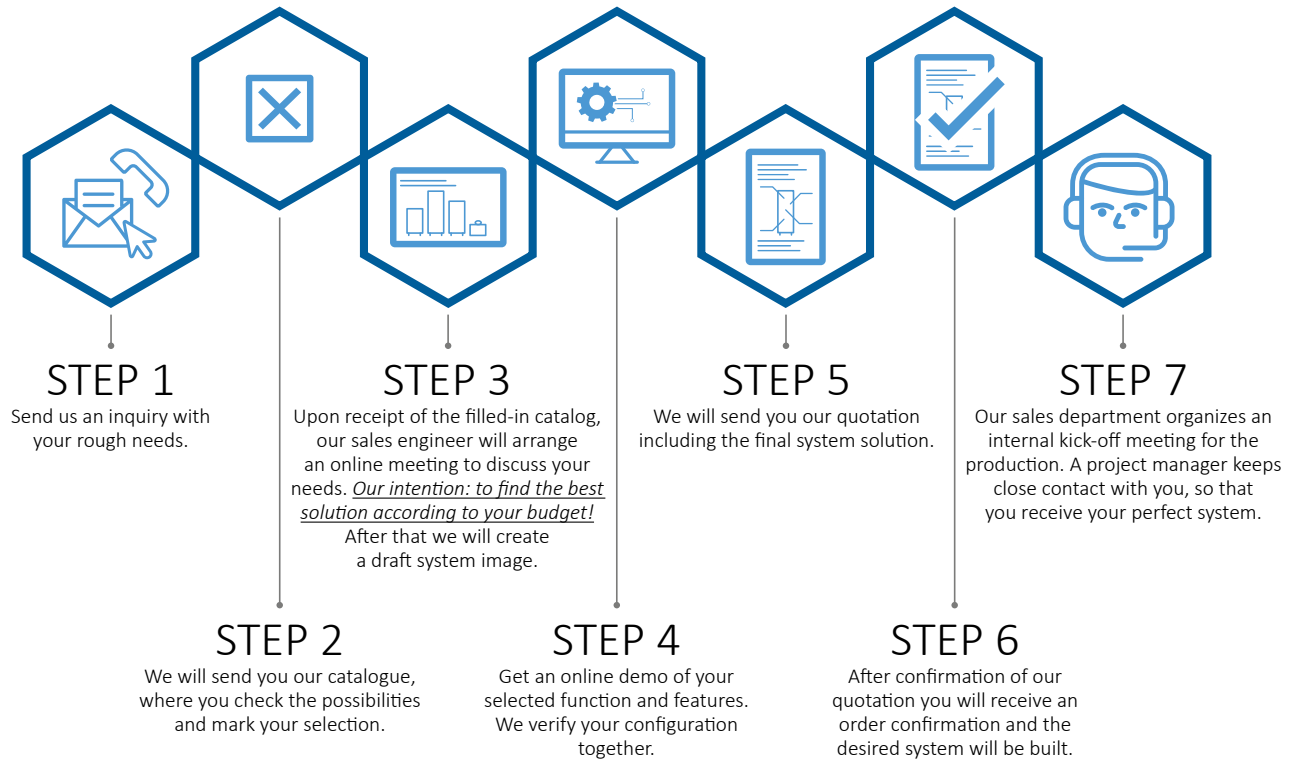

Get the perfect matching system and software for your application that makes the charging process easy to analyze and test!



Devices for mobile and rack use as well as for all standards available worldwide. Devices and components shown in the brochure are examples. The actual appearance differs depending on the chosen variant.

comemso GmbH
Karlsbader Str. 13
D - 73760 Ostfildern
Mail: sales@comemso.de
Phone: +49 711 500 900 40
www.comemso.com

comemso[®]
your partner for complex embedded solutions